

STEIGER® T 700 HF

HEIGHT
performance
highflex



STEIGER® T 700 HF



70 m working height with not even 12 m vehicle length!
Extremely compact, manoeuvrable and always operational



Perfect handling through a compact design. For tight manoeuvring e.g. in city traffic

→ Always ready for use

TOP PERFORMANCE DATA*



70 m working height



41 m lateral outreach



2° permissible inclination



Overall length only 11.99 m



83° angle of elevation



Registration possible with 32 t (up to 36 t)

*depending on chassis and equipment

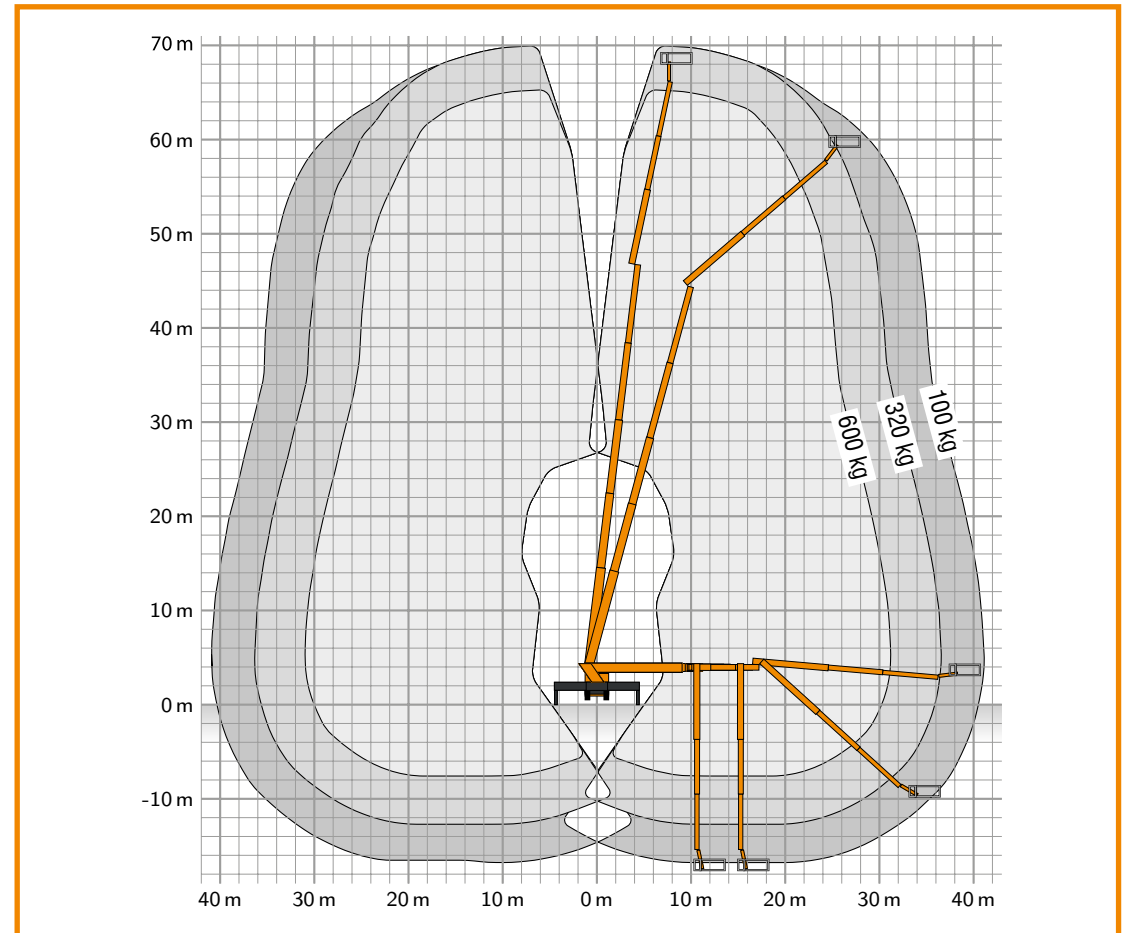

STEIGER® T 700 HF



- i** The **best from the RUTHMANN world** combined with an even longer upper boom.
- +** **More flexibility in use, also under narrow conditions (projecting edges, foreparts)**

+ **24.6 m**
TOTAL UPPER BOOM OUTREACH
+3.5 m more as on the T 650 HF

+ **Inflexion point + 1.7 m**
more effective "up, over and back" working

+ **Easy and flexible working**
Optimised utilisation of the outreach: Overhangs can simply be bridged; it can at the same time be worked close to the object

+ **Three-fold upper boom**
for more manoeuvrability

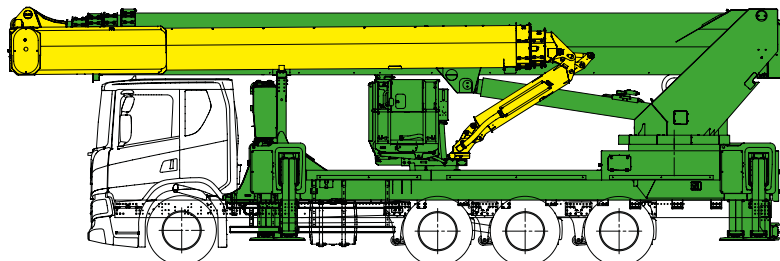

Same as on
T 650 HF
NEW



STEIGER® T 700 HF

+ Retracted upper boom telescope



T 700 HF

Competition

Max. extended upper boom telescope



T 700 HF

Competition

THREE-FOLD UPPER BOOM FOR MORE MANOEUVRABILITY

+ Double effect: Compact in retracted state and high outreach thanks to the three-fold upper boom

+ Optimal straightening with small place requirement

EVEN MORE UNDERFLOOR PERFORMANCE

+ Underfloor working possible up to 17 m
+ 5 m more than the competition

+ Effective use due to the 440°
basket rotation angle

+ Thanks to the additional movable RÜSSEL®
ideal for bridge inspections

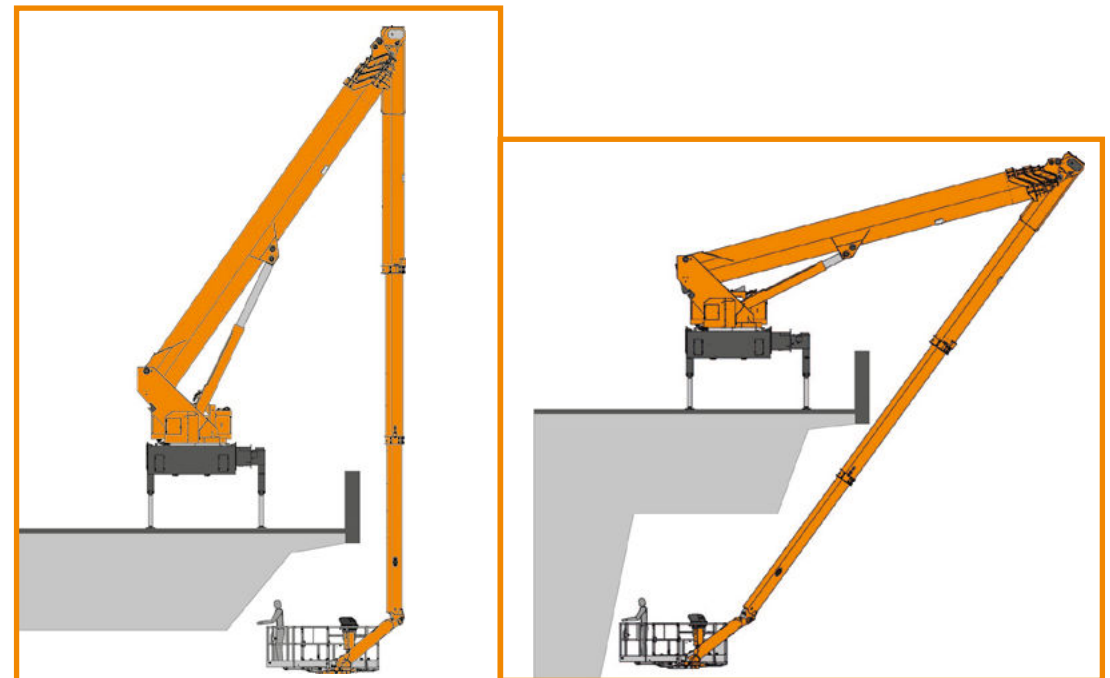



Significantly MORE flexibility in use,
with the highflexRÜSSEL®



220°

Real rotating angle of the RÜSSEL®'s by
optimised basket boom articulation

+ 10° MORE



2.0 m RÜSSEL® length
therefore 6 m flexibility on the object



40° MORE RÜSSEL® rotation



Standing working basket ideal
for „under and up“ as well as all
possibilities of „up and over and
back“ with lowered RÜSSEL®

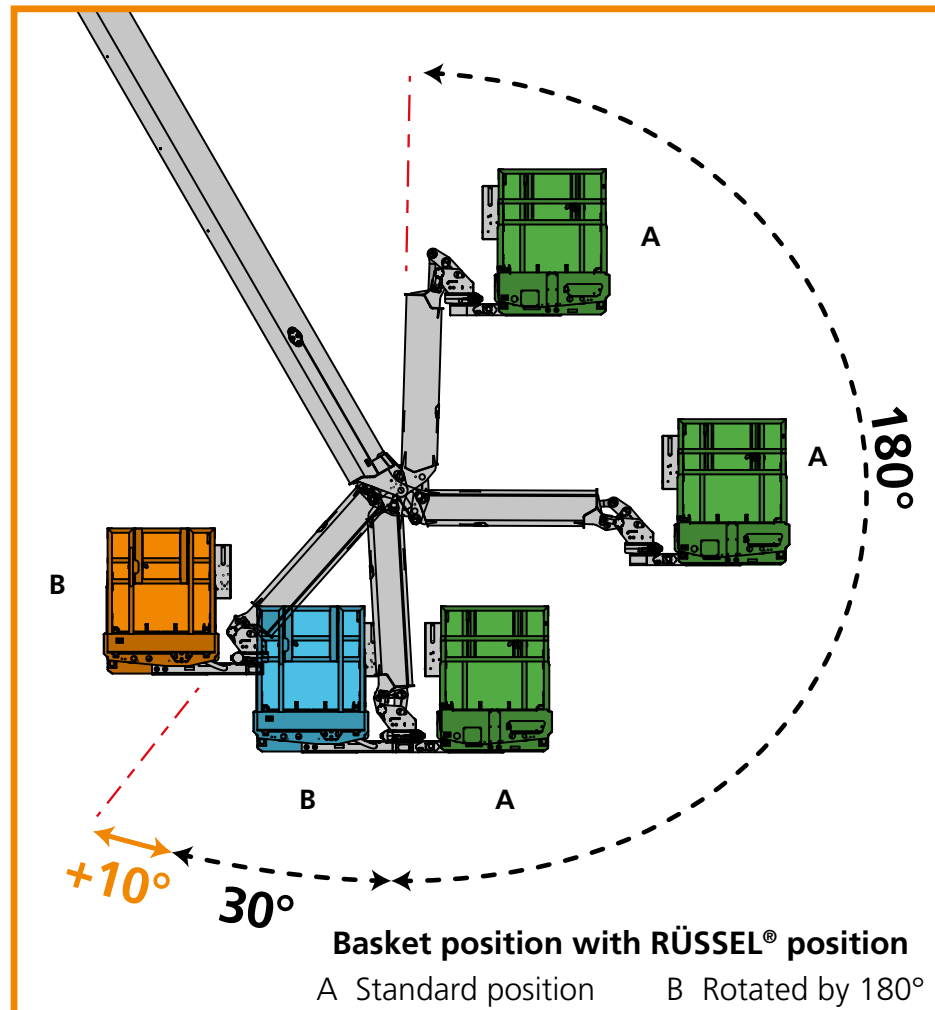

More flexibility in use with the highflexBASKET

- + Maximum basket rotating angle
- + 2 x 220° basket rotation
- + Largest basket on the market
3.82 m x 0.97 m extended
- + 600 kg basket load
- + Less disruptive factors in the basket
- + All positions also possible with extended basket

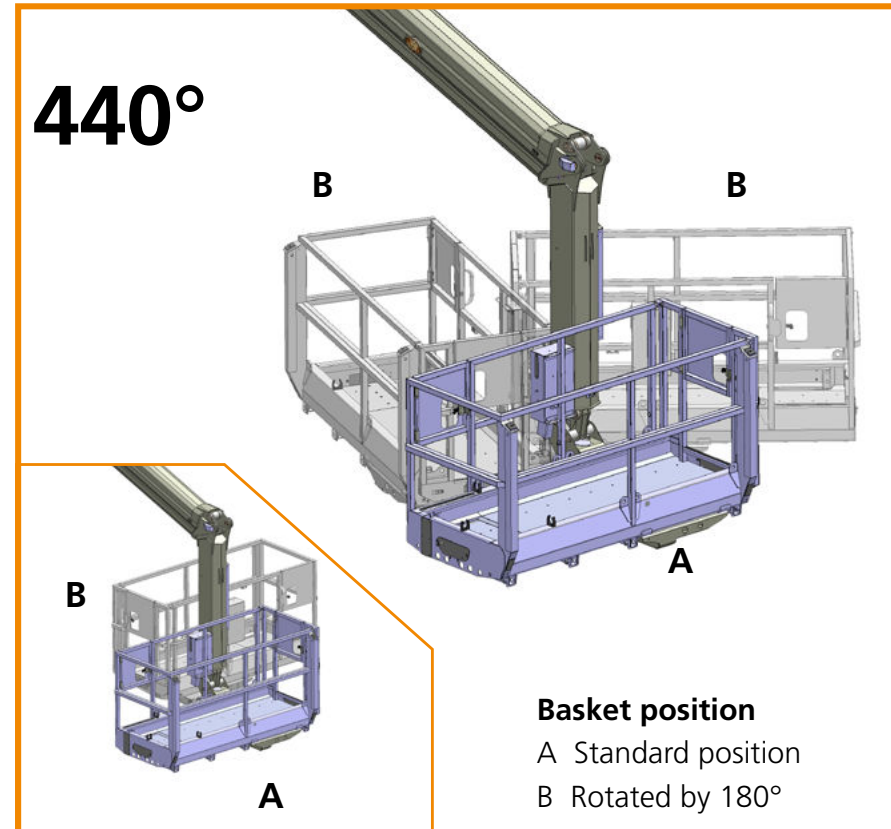

New construction with even more features and optional extras



- + Stable design, reinforced floor
- + Barrier-free, heating, illuminated basket floor
- + New lift-up system (+25 kg payload)
- + Camera basket
- + Material winch
- + Basket floor lighting
- + Movable folding seat
- + More cleaning openings
- + Periphery lighting and much more



i Proven chassis for selection!
High flexibility and easy handling

CHASSIS CHOICE

- + Permissible GVWR 32 - 36 t
- + Types of drive 8 x 2, 8 x 4
- + Axle combination 1-3
- + Extremely compact front overhang
- + Standard or long driver's cab
- + Compact turning circle due to the axle combination 1-3 in connection with a steerable trailing axle
- + High service availability throughout Europe



only exemplary illustrations of the brand and chassis variants



i even MORE HEIGHTperformance advantages and features

PROVEN TECHNOLOGY AND FEATURES

- + Stable boom system through proven profile with multiple edging of the high-tech steel
- + 3-fold upper boom telescope, complete extendable also with 600 kg basket load
- + Easy handling through same function and handling as with the previous STEIGER® large-scale models
- + Full control stand at turret (option)
- + U-plates mounted on the jacks
- + COCKPIT (control unit in the basket)
- + VARIOUS jack control stands basket – vehicle rear (left + right) – alternate control

- + Component similarity to other models providing ADDED value
- + In the procurement and stocking of spare parts
- + For service / maintenance
- + For storage / costs





USEFUL optional extras

MORE comfort
MORE safety
MORE efficiency

... **A MUST** for large-scale machines

ONLY A FEW EXAMPLES

- + Lift-up system for safe lifting of material in the basket
- + Box attachments and bodies for safe carrying of plenty tools and material
- + Generator
- + Illuminating equipment on the vehicle / at the jacks, on and at the basket
- + Heating systems for the COCKPIT control stand and basket floor
- + First-aid kit in the basket

- + Movable folding seat for the operator in the basket
- + Camera fastening devices for TV productions
- + Lower boom camera
- + and much more.

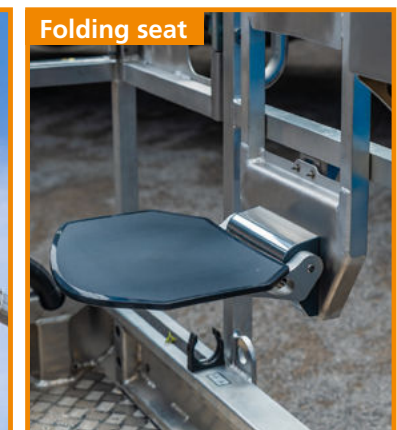

DRS as optional extra

- + Thanks to the RUTHMANN DRS, you dispose of previously unthinkable performance data
- + The DRS generates more working range, more outreach and therefore more flexibility in use
→ more utilisation, turnover and quicker ROI
- + On-Board outreach calculation in real time

DRS = MORE outreach

All in all, the DRS offers enormous additional benefits that are not available anywhere else in the truck-mounted working platform industry.

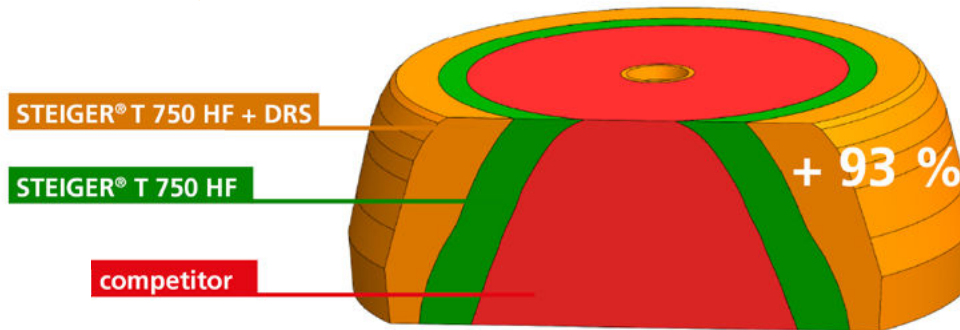

**DYNAMIC
REACH
SYSTEM**



- more utilisation
- more turnover
- quicker ROI

ADDITIONAL OPTIONS FOR THE DRS

SUPPORT LOAD ASSISTANCE SYSTEM

Work at 50 % support load

Each jack can individually be preset in 6 levels: 50 %, 60 %, 70 %, 80 %, 90 % and 100 % of the maximal support load.

WIND ASSISTANCE SYSTEM

Work at wind force 7 or 8

Adjust wind force before starting work. The DRS adjusts the possible outreach under the premise of the maximum basket stability.

BASKET PAYLOAD ASSISTANCE SYSTEM

Work in the basket with 600 kg

Simply preset the desired basket load.
3 selectable levels: deactivated, 320 kg or 600 kg.

STEIGER® T 700 HF





 Worldwide available **RUTHMANNSERVICE**



 Unmatched service quality and diversity through company-owned customer service!

 Multilingual 24/7 telephone hotline support in all desired quality levels

 Largest spare-parts warehouse with the fastest, worldwide spare-parts dispatch and highest delivery capacity

 Highly professional, worldwide deployable service technician taskforce and video service

 Market-leading information and diagnosis system in the state-of-the-art control panel "COCKPIT" for comprehensive worldwide remote diagnostic availability



Extremely compact, manoeuvrable and always operational!

Does the RUTHMANN STEIGER® T 700 HF convince you? We would be pleased to provide you with more details.
 Thanks a lot for your interest!



All data has been included without warranty. All measurements and weights are approximate and refer to the standard basic execution. Technical alterations reserved.

Advantages overview

- 70 m working height
- 41 m outreach
- Compact turning circle (11.99 m) due to the axle combination 1-3 in connection with a steerable trailing axle
- Extremely compact with minimal front overhang
- highflexRÜSSEL® → 220° movement range
- highflexBASKET → 440° rotating range
- Even longer upper boom
- Multi-chassis possibilities: brands, driver's cab types, types of drive (8x2, 8x4)
- Most recent control and operation technology (COCKPIT)
- Comprehensive optional extras
- Worldwide available service
- Numerous worldwide references

STEIGER® T 700 HF

Ruthmann Holdings GmbH

Ruthmannstraße 4
 48712 Gescher
 GERMANY

Phone: +49 2863 204-0
 Fax: +49 2863 204-212

Internet: www.ruthmann.de
 E-mail: info@ruthmann.de